

SCHWIMMBADLIFTER + SOCKEL A

SCHWIMMBADLIFTER

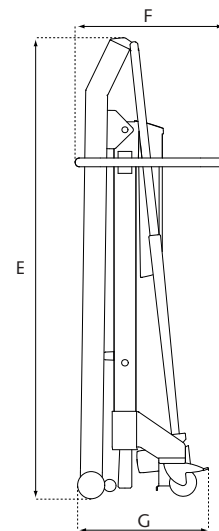
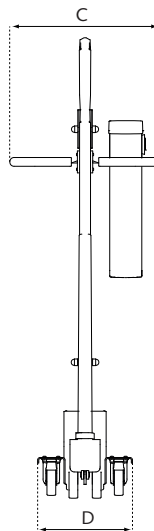
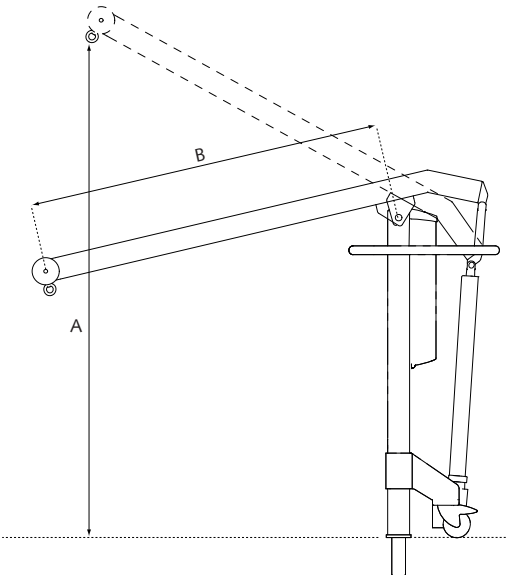

Abmessungen (mm)

A	1840
B	1305
C	540
D	350
E	1700
F	550
G	500

Max. Hubkraft	135 kg
Batterien	2 x 12 Vdc; 6,5 - 7,2 Ah
Ladegerät	separat

Durchmesser der Räder	100 mm
Konstruktion	beschichtetes Aluminium ; RVS
Handbedienung	elektrisch IP67

SOCKEL A

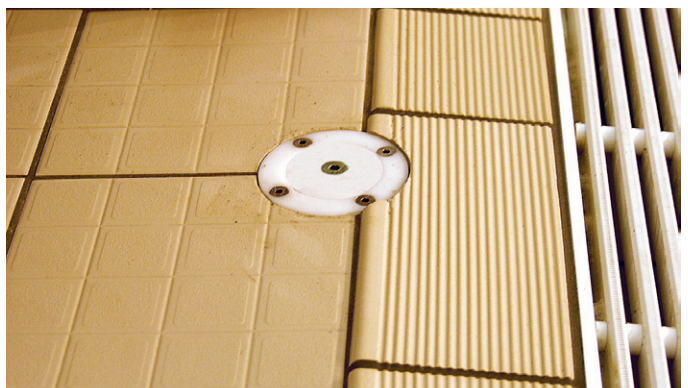

KÖRPERUNTERSTÜTZUNG

Hebebügel

S	ref. 1025
S elektrolytisch poliert (Korrosionsschützend)	ref. 1027

+ Gleitschutzbeinstützen ref. 1080

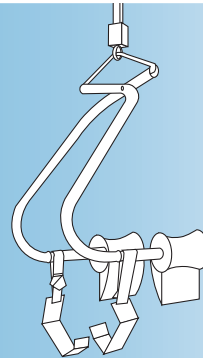

Hebetuch Standard mit mondformiger Kopfstütze und gepolsterte Beinschlaufen

XS	ref. 3433
S	ref. 3430
M	ref. 3431
L	ref. 3432
XL	ref. 3434

+ Einhängenvorrichtung
ref. 2110 + 2111

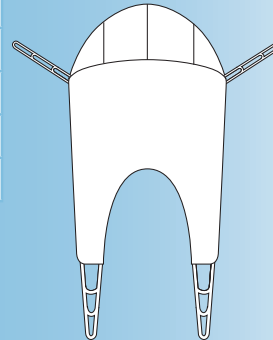
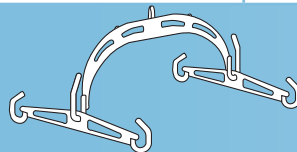

Badesitz (PVC)

Unisize	ref. 3473
---------	-----------

+ Einhängenvorrichtung
ref. 2110

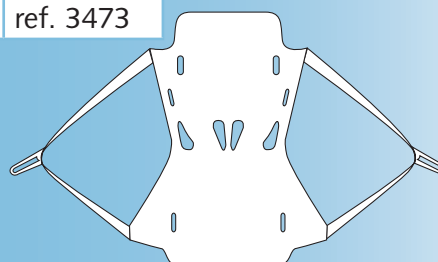
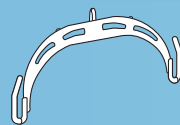

Badehebetuch (PVC)

XS	ref. 3476
S	ref. 3463
M	ref. 3464
L	ref. 3465
XL	ref. 3477

+ Einhängenvorrichtung
ref. 2110

